



TELESCOPIC TRIBUNE



Cultural tribunes / Sport facilities tribunes

INTRODUCTION ALAUTORDERA workshop	04
CERTIFICATIONS CERTIFICATES AND QUALITY STANDARDS	05
DESIGN OPTIONS CUSTOM PROJECTS	06
GATEL200 RETRACTABLE TRIBUNE ARMCHAIR OVER GRANDSTAND	08
GATEL210 RETRACTABLE TRIBUNE ARMCHAIR FRONT OF THE GRANDSTAND	10
GATEL215 RETRACTABLE TRIBUNE WITH FOLDABLE ARMCHAIR FRONT OF THE GRANDSTAND	12
GATEL220 RETRACTABLE TRIBUNE WITH LIFTABLE AND FOLDABLE ARMCHAIR OVER THE GRANDSTAND	14
CARRILES TRANSFER LANES FOR ARMCHAIRS	16
GATEL100 TELESCOPIC TRIBUNE WITH WOODEN BENCH SEAT WITHOUT BACKREST	17
GATEL110 TELESCOPIC TRIBUNE WITH POLYPROPYLENE BENCH SEAT WITHOUT BACKREST	18
GATEL120 TELESCOPIC TRIBUNE WITH POLYPROPYLENE SEMI-BACKREST SEAT	19
GATEL130 TELESCOPIC TRIBUNE WITH POLYPROPYLENE BACKREST SEAT	20
GATEL140 TELESCOPIC TRIBUNE WITH FOLDABLE POLYPROPYLENE BACKREST SEAT	21
GATEL150 TELESCOPIC TRIBUNE WITH FOLDABLE POLYPROPYLENE SEAT FRONT OF THE GRANDSTAND	22
GATEL160 TELESCOPIC TRIBUNE WITH AUTOMATIC POLYPROPYLENE FOLDABLE AND LIFTABLE SEAT FRONT OF THE GRANDSTAND	23



INTRODUCTION

Talleres Palautordera, S.A. (TP SPORT) is a company dedicated to the production, design and installation of sports equipment, sports facilities, tribunes and grandstands. Founded in 1983 it stands out for its vast experience within the sector. Our developments, designs and installations of telescopic tribunes can be for the following areas within the sports fields (sports centres, arenas schools, gyms, etc.) or for cultural areas (theatres, multi-purpose rooms, conference rooms, etc.).

The telescopic grandstands or bleachers made by TP SPORT have been designed to perfectly fit all kinds of multipurpose rooms (entertainment rooms, sports venues, lectures, theatres, etc...). The modular concept of TP SPORT's telescopic bleachers which are adaptability and low interference allow the creation of specific areas in a short time.

AT **TP SPORT** we specialize in::

DESIGN AND DEVELOPMENT OF PROJECTS: TP SPORT has a technical department that studies each project according to the needs raised by the customer, offering a detailed and specific technical proposal for each project.

PRODUCTION: TP SPORT has its production facilities located north of Barcelona, where we have the production line and the quality control.

QUALITY: TP SPORT 's R+D Department, studies, works and constantly develops new solutions for your telescopic bleachers, giving the opportunity to offer unique products.

INSTALLATION: Our team of qualified technicians guarantees the set up anywhere in the world. We provide customised technical support for each installation.

GUARANTEE: TP SPORT equipment has 2 years guarantee.

CERTIFICATIONS

TP SPORT, in compliance with EU Regulation 305/2011 of the European Parliament complies with EN 1090-1: 2009 + A1: 2011 Of Factory Production Control for structures and structural metal components for use in steel structures or in mixed steel and concrete structures. Certificate number TP SP or CE accordance 2449/CPR/AC-CA02.



In its commitment to quality, we are certified UNE EN ISO 9001 "quality management systems". Likewise, we have a declaration of principles of Quality Policy at your disposal, request via e-mail.

The telescopic bleachers are designed and manufactured according to the following standards:

UNE EN 1090-1:2009+A1:2011. Execution of steel structures and aluminium structures

- Part 1: Requirements for conformity assessment of structural components.

UNE-EN 13200-2006. Spectator facilities:

- Part 1: Layout criteria for spectator viewing area - Specification
- Part 3: Separating elements - Requirements
- Part 4: Seats - Product characteristics
- Part 5: Telescopic stands
- Part 6: Demountable (temporary) stands

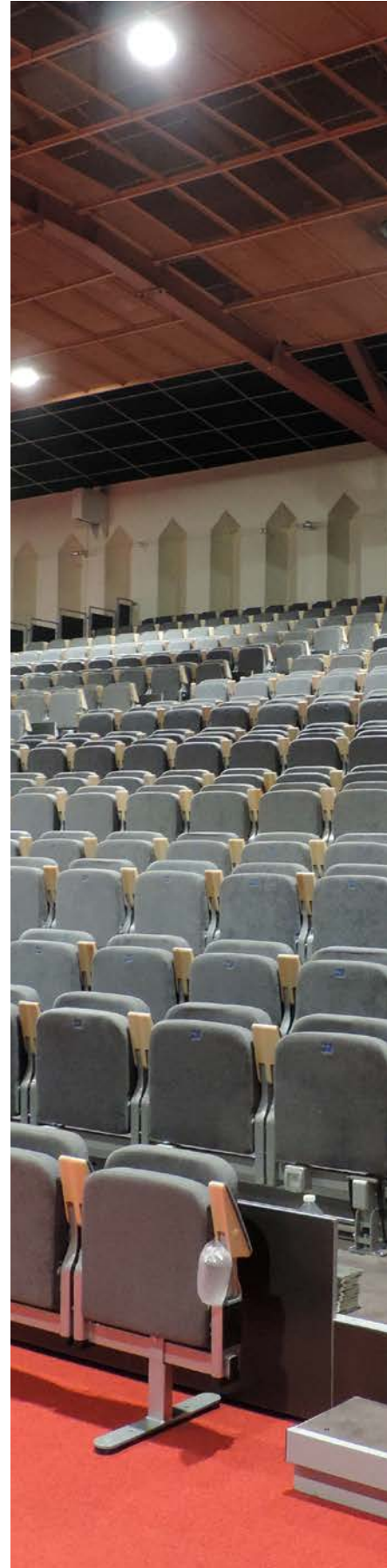

DESIGN OPTIONS

TP SPORT telescopic stands are manufactured in modules with a support structure made of S235 JOH steel profiles according to the UNE 13200-2006, DIN 1055 and 18032 standards, bearing a vertical load of 500 kg / m². In the isles and steps a vertical dynamic load of 7.5 kn / m is assumed, at each row pavement level it bears a horizontal load of 3.5 kn/m and a horizontal stress in both directions equal to 1.2 of the vertical load to consider the movements of the spectators. All metal structure is manufactured with steel JR S-235 according to the standard DIN 18800 Part 7.

The grandstand slides with the help of the 125 mm wheels. of diameter and 40 mm. wide. Each grandstand has a mechanical safety system to ensure the safety of spectators.

Operational options

Motorised / manual

Armchair Abatement

The seats can be:



Manual

Manual without effort for full row but with activation by 2 operators.



Mechanical automatic

Manual without effort helped by gas pistons and on benches of 2 - 3 - 4 - 5 - Uts



Automatic linear motor

Automatic by full row through the harrow traction motors

Floor

The floor finish can be linoleum, PVC, carpet of different qualities and all kinds of parquet.

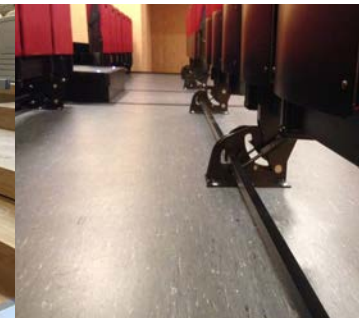

DESIGN OPTIONS

Each grandstand has a mechanical safety system to ensure the safety of spectators

Protective Railing

They can be fixed, removable or telescopic.

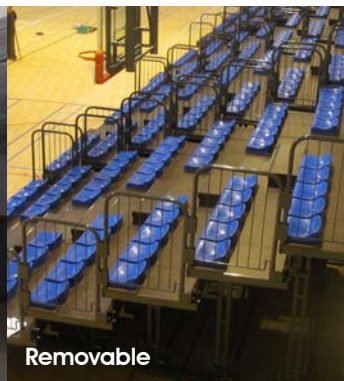

Lateral Enclosure

Can be made of curtain, DM Wood, PVC lateral curtain...



Front

In order to hide the seats, only possible if the measurement of the platform is at least 950 mm wide. The finish can be MD lacquered wood, various types of parquet, phenolic HPL of different qualities and thicknesses ...



TELESCOPIC TRIBUNE
CULTURAL CENTRES,
AUDITORIUMS AND THEATRES

GATEL200

TELESCOPIC TRIBUNE WITH ARMCHAIR OVER THE GRANDSTAND

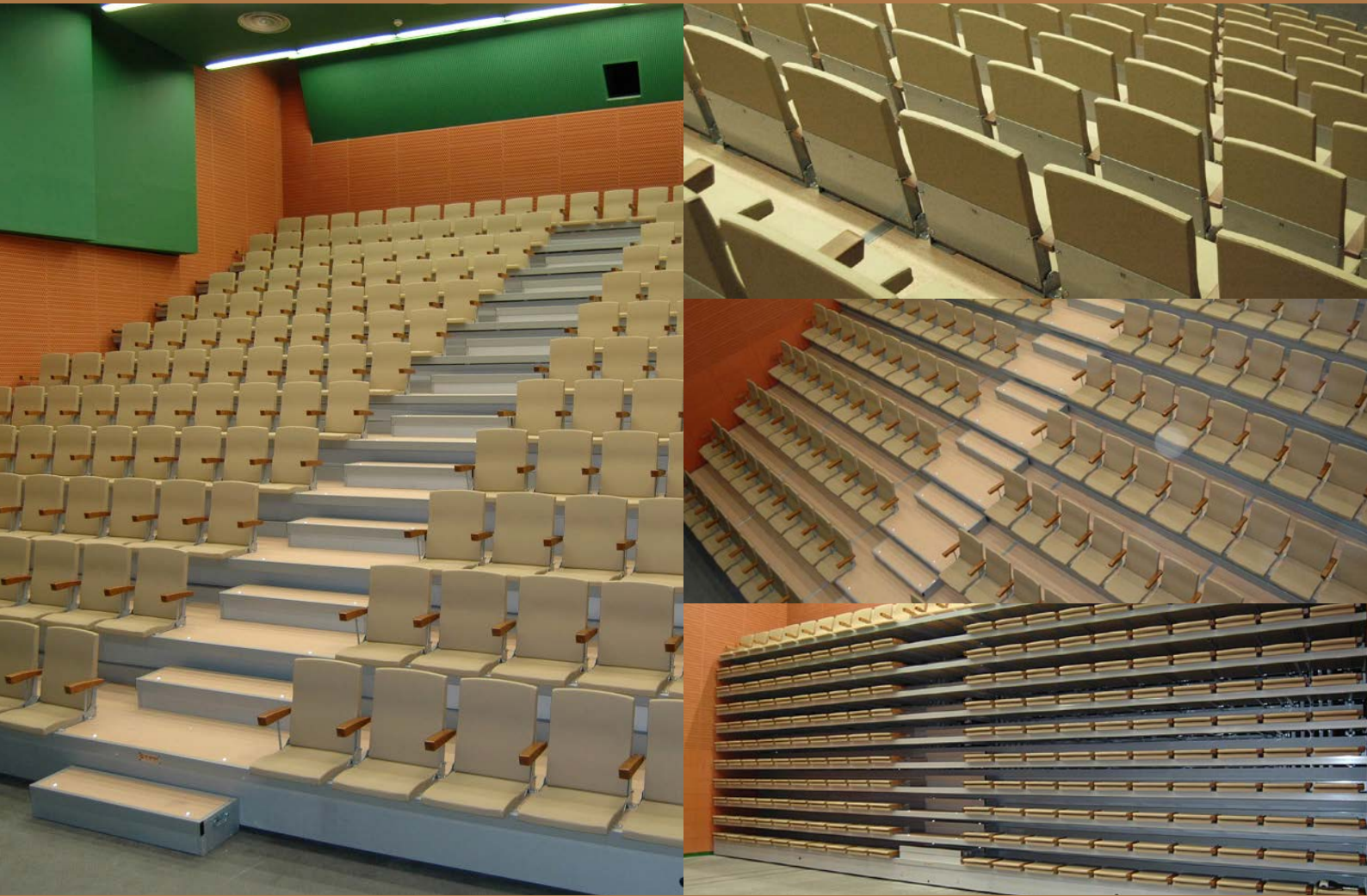

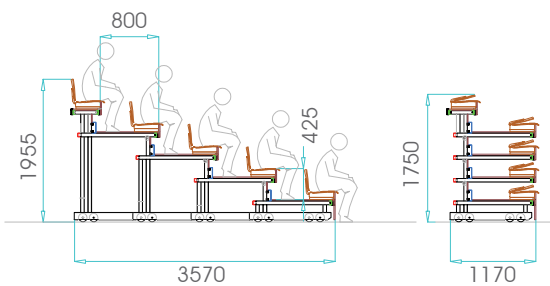

Telescopic tribune with armchair over the grandstand
Taylor made according to customer needs.

TELESCOPIC TRIBUNE
CULTURAL CENTRES,
AUDITORIUMS AND THEATRES

GATEL210

RETRACTABLE TRIBUNE ARMCHAIR FRONT OF THE GRANDSTAND



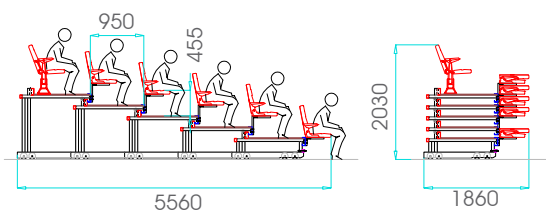
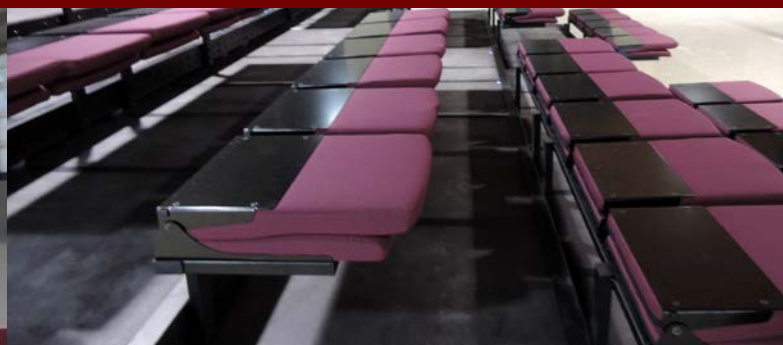

Retractable tribune armchair front of the grandstand.

Taylor made according to customer needs.

TELESCOPIC TRIBUNE
CULTURAL CENTRES,
AUDITORIUMS AND THEATRES

GATEL215

RETRACTABLE TRIBUNE WITH FOLDABLE ARMCHAIR FRONT OF THE GRANDSTAND

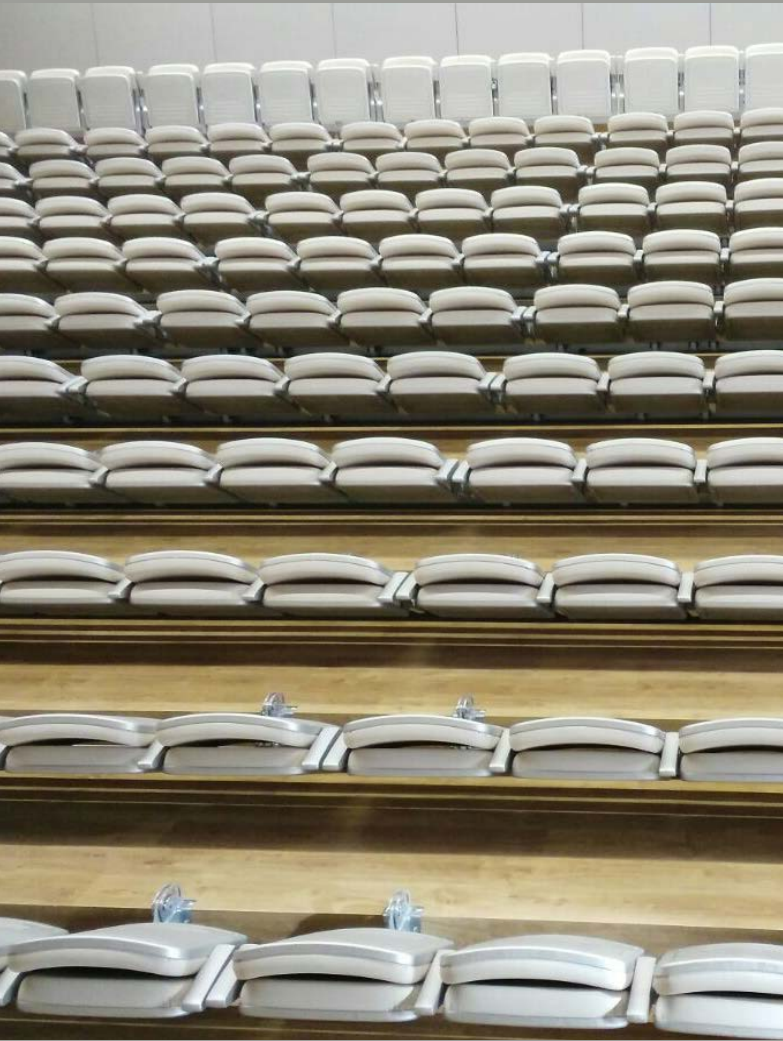

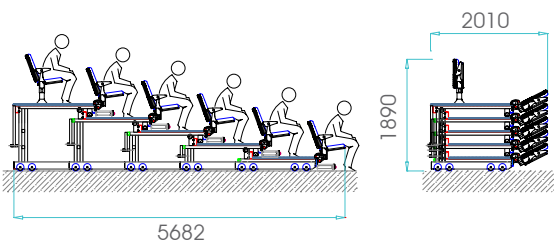
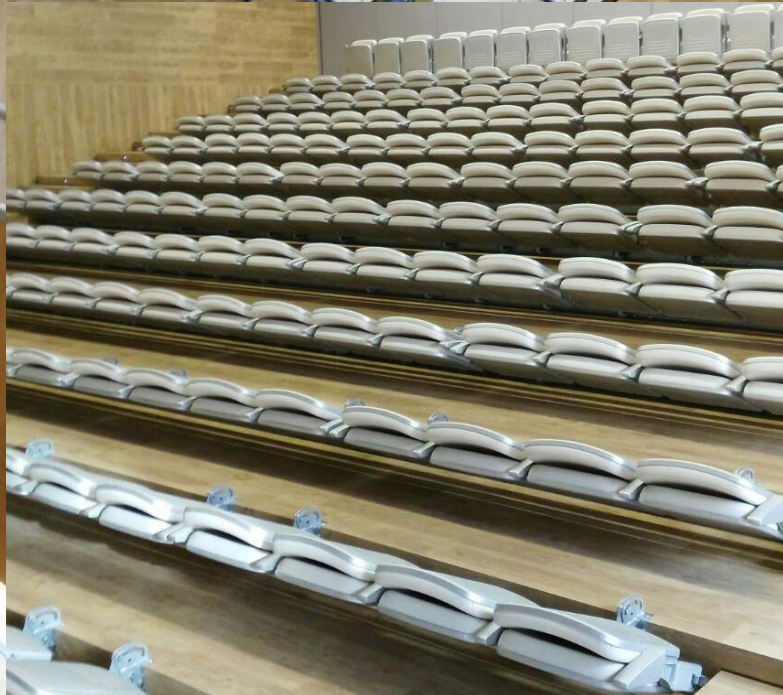

Telescopic tribune with with foldable armchair front of the grandstand

Taylor made according to customer needs.

TELESCOPIC TRIBUNE
CULTURAL CENTRES,
AUDITORIUMS AND THEATRES

GATEL220

RETRACTABLE TRIBUNE WITH LIFTABLE AND FOLDABLE ARMCHAIR OVER THE GRANDSTAND

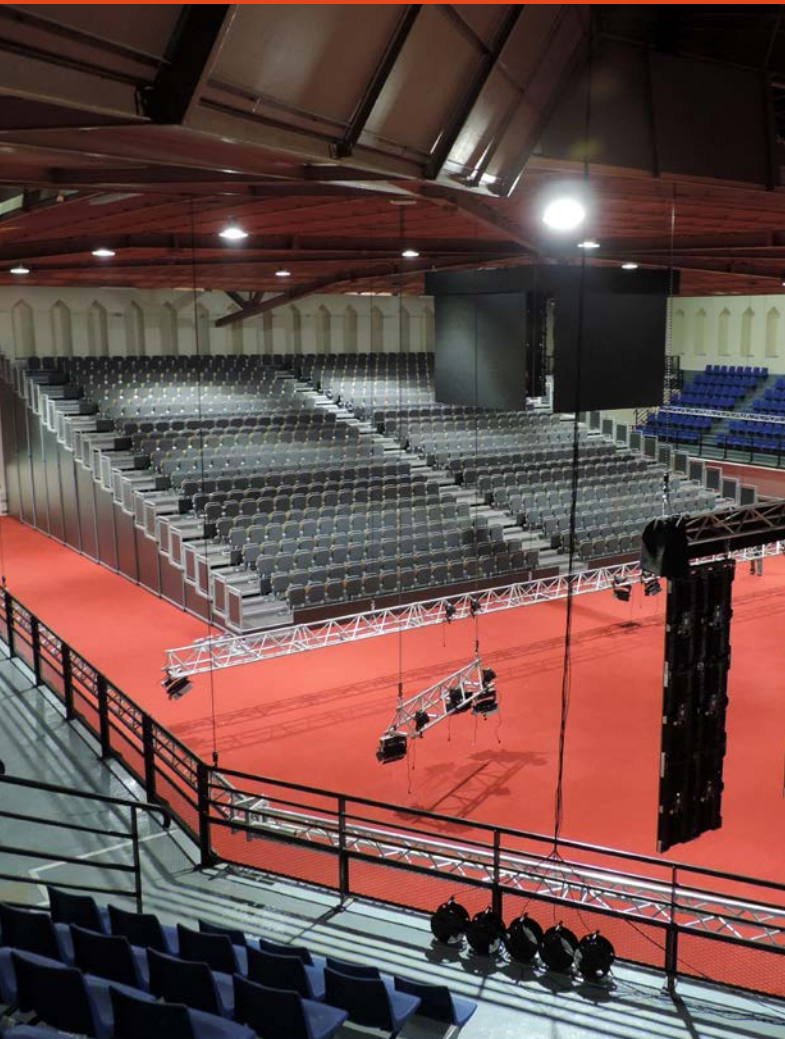

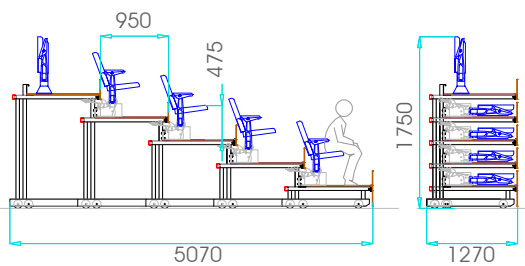
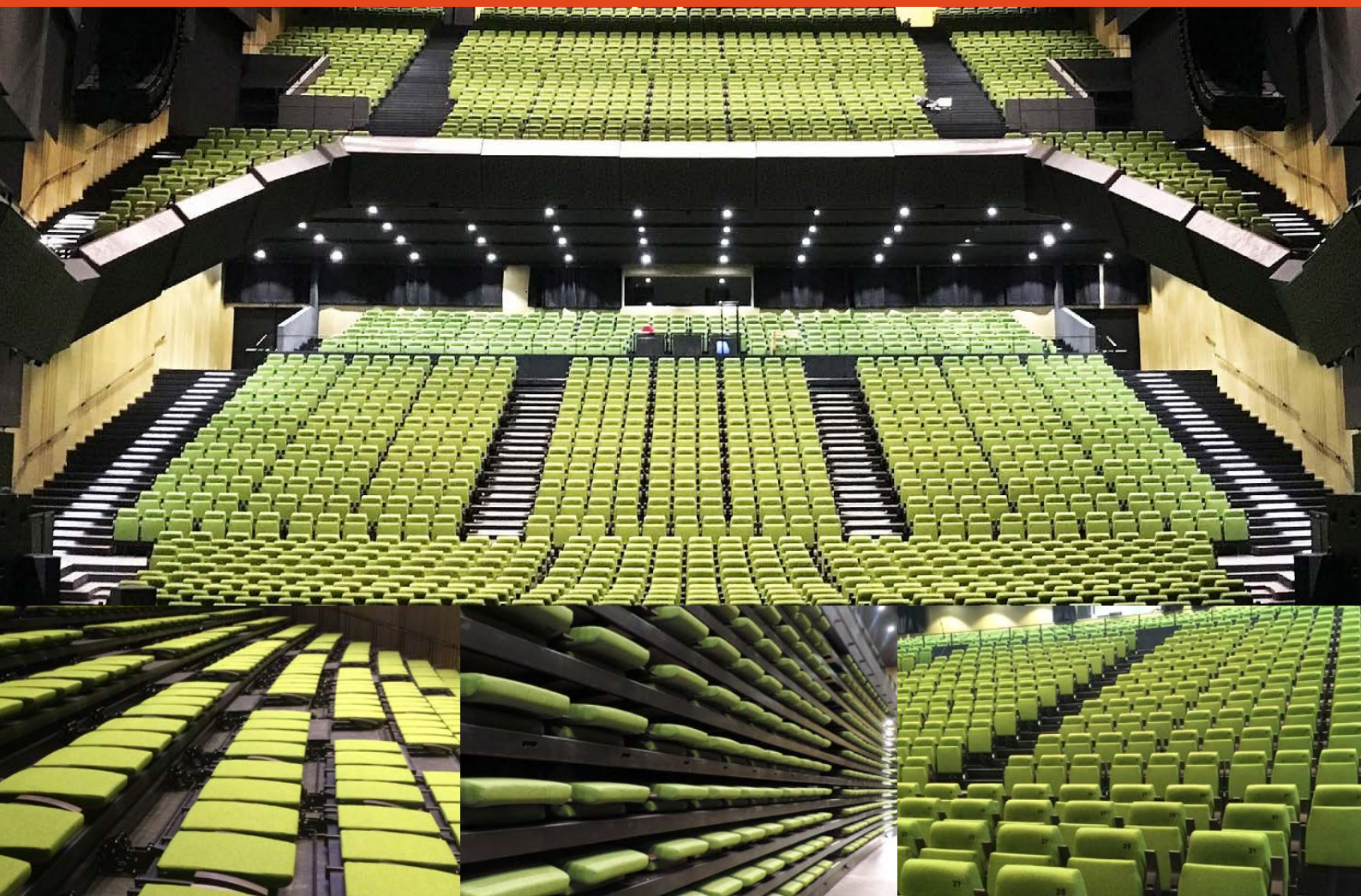

Retractable tribune with liftable and foldable armchair over the grandstand

Taylor made according to customer needs.

TELESCOPIC TRIBUNE
CULTURAL CENTRES,
AUDITORIUMS AND THEATRES

Rail systems for the traslation of the chairs

WE HAVE TWO RAIL SYSTEMS FOR THE TRASLATION OF THE CHAIRS.

The rails systems are embedded in the pavement of the room to move the rows whole seats up to a maximum of 16 units. The rails can be:

Manual traslation rails

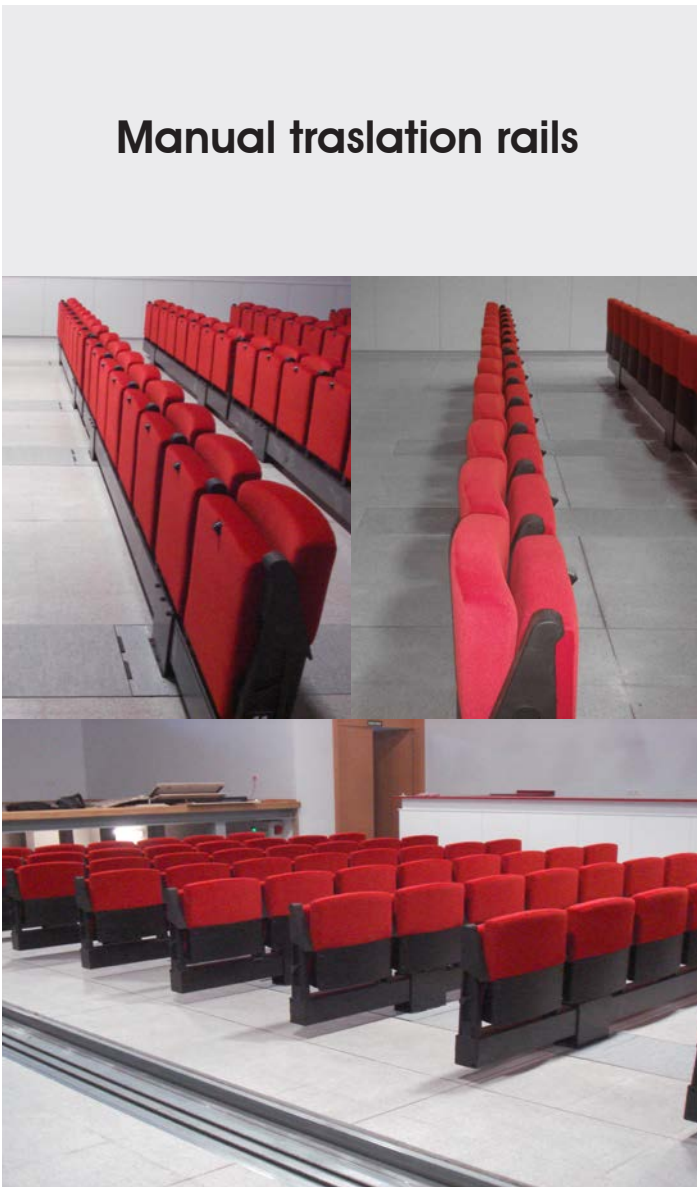

Motorised traslation rails

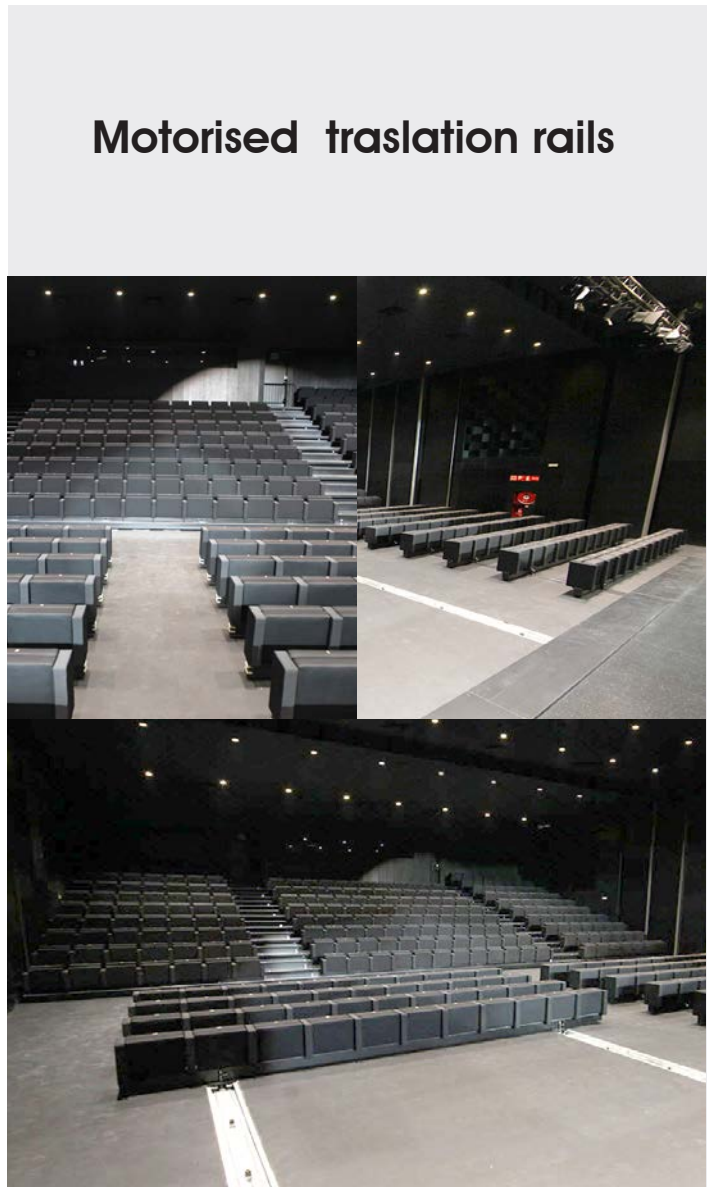

TELESCOPIC
TRIBUNES FOR
SPORTS FACILITIES

GATEL100

TELESCOPIC TRIBUNE WITH WOODEN BENCH SEAT WITHOUT BACKREST

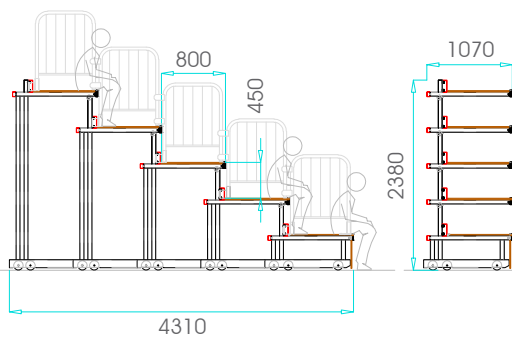

Telescopic tribune with wooden bench seat
without backrest.

Taylor made according to customer needs.

TELESCOPIC
TRIBUNES FOR
SPORTS FACILITIES

GATEL110

TELESCOPIC TRIBUNE WITH POLYPROPYLENE BENCH SEAT WITHOUT BACKREST

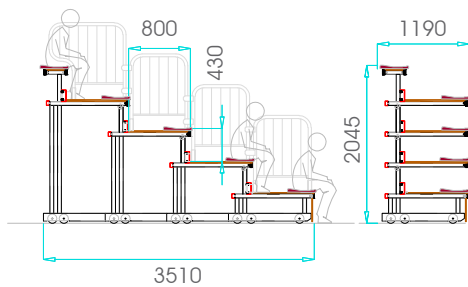

Telescopic tribune with polypropylene bench seat without backrest.

Taylor made according to customer needs.

TELESCOPIC
TRIBUNES FOR
SPORTS FACILITIES

GATEL120

TELESCOPIC TRIBUNE WITH POLYPROPYLENE SEMI-BACKREST SEAT

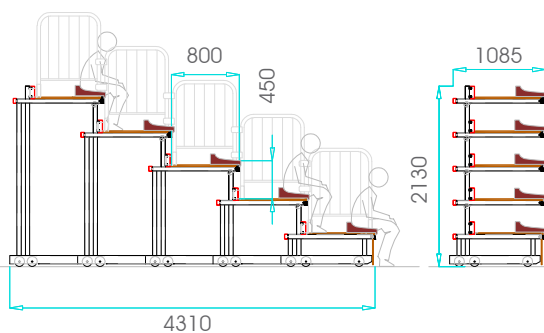

Telescopic tribune with polypropylene semi-backrest seat.

Taylor made according to customer needs.

TELESCOPIC
TRIBUNES FOR
SPORTS FACILITIES

GATEL 130

TELESCOPIC TRIBUNE WITH POLYPROPYLENE BACKREST SEAT

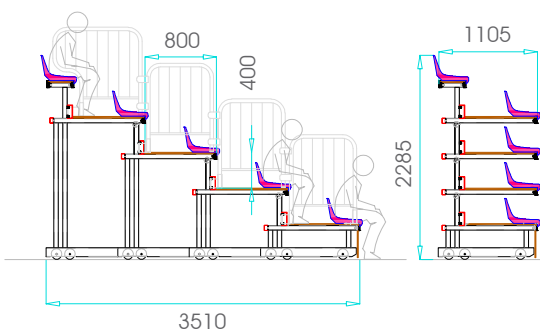

Telescopic tribune with polypropylene backrest seat.

Taylor made according to customer needs.

TELESCOPIC
TRIBUNES FOR
SPORTS FACILITIES

GATEL140

TELESCOPIC TRIBUNE WITH FOLDABLE POLYPROPYLENE BACKREST SEAT

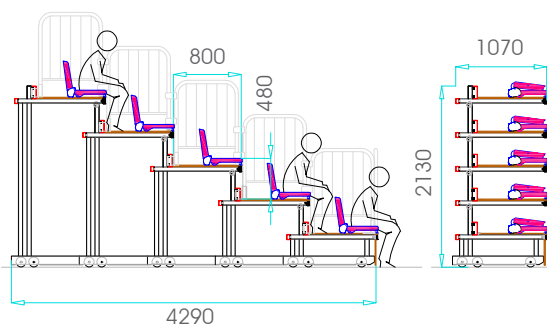

Telescopic tribune with foldable polypropylene backrest seat.

Taylor made according to customer needs.

TELESCOPIC
TRIBUNES FOR
SPORTS FACILITIES

GATEL150

TELESCOPIC TRIBUNE WITH FOLDABLE POLYPROPYLENE SEAT FRONT OF THE GRANDSTAND

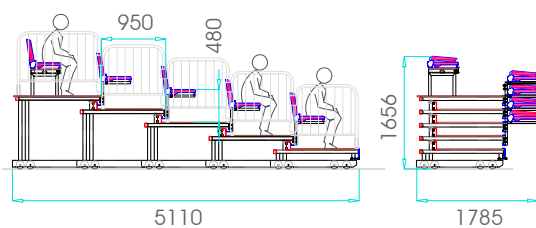

Telescopic tribune with foldable polypropylene seat front of the grandstand.

Taylor made according to customer needs.

TELESCOPIC
TRIBUNES FOR
SPORTS FACILITIES

GATEL160

TELESCOPIC TRIBUNE WITH AUTOMATIC POLYPROPYLENE FOLDABLE AND LIFTABLE SEAT FRONT OF THE GRANDSTAND

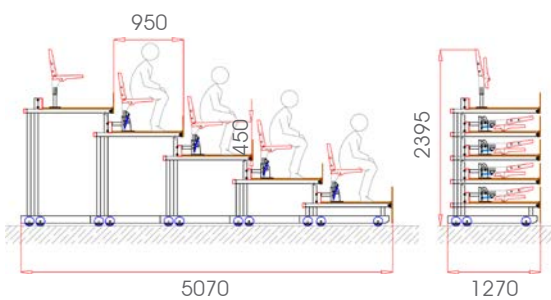
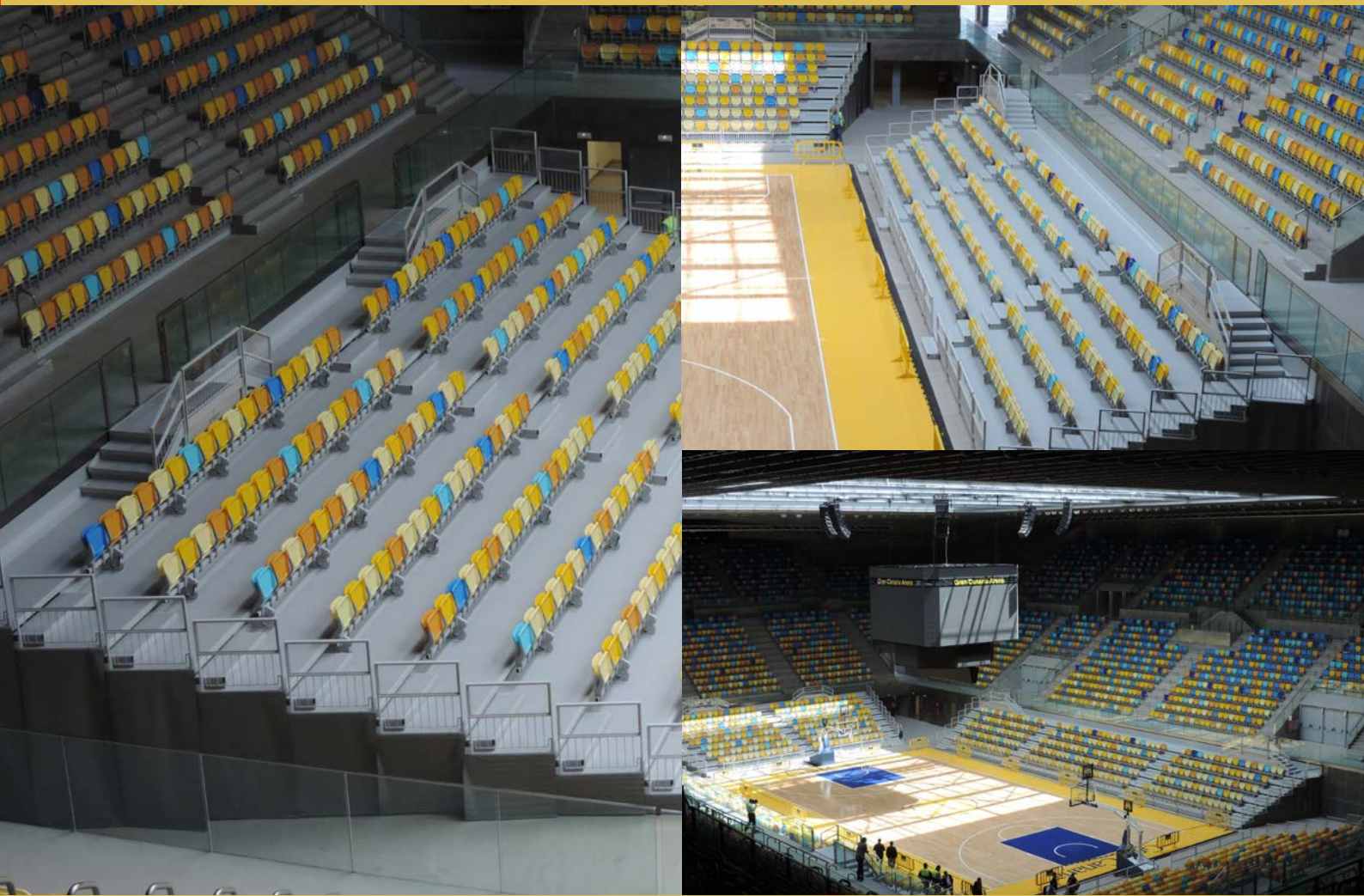

Telescopic tribune with automatic polypropylene foldable and liftable seat front of the grandstand.

Taylor made according to customer needs.



TP SPORT

TALLERES PALAUTORDERA, S.A.

Pol. ind. Molí de les Planes, s/n

Tel. 93 867 37 42 - Fax 93 867 43 62

08470 SANT CELONI (Barcelona)

info@tpsport.net

www.tpsport.net