

PROFESSIONAL BASKETBALL GOAL

TP SPORT

REF. BAMUE

DESCRIPTION

Professional basketball goal set portable and liftable achieved by springs, extension 3250 mm.

Constructed as per norm FIBA D=9906 and norm UNE-EN 1270:2005 type 1 and 8 class A-B-C-D-E, made in steel structural tube, comprised by a base with two double vertical poles and a horizontal arm which fixes the rim. All of it attached through axis with directional bearings, being auto lubricated and with a special security metallic support.

GENERAL OUTLINE OF THE COMPONENTS OF THE BASKETBALL GOAL

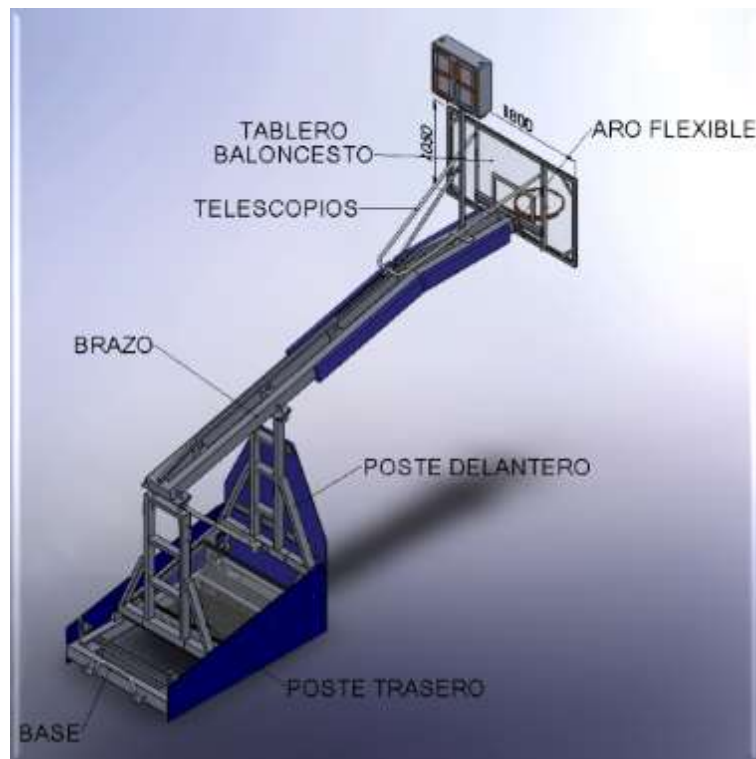

SCHEME MEASURES OF UNFOLDED BASKETBALL GOAL

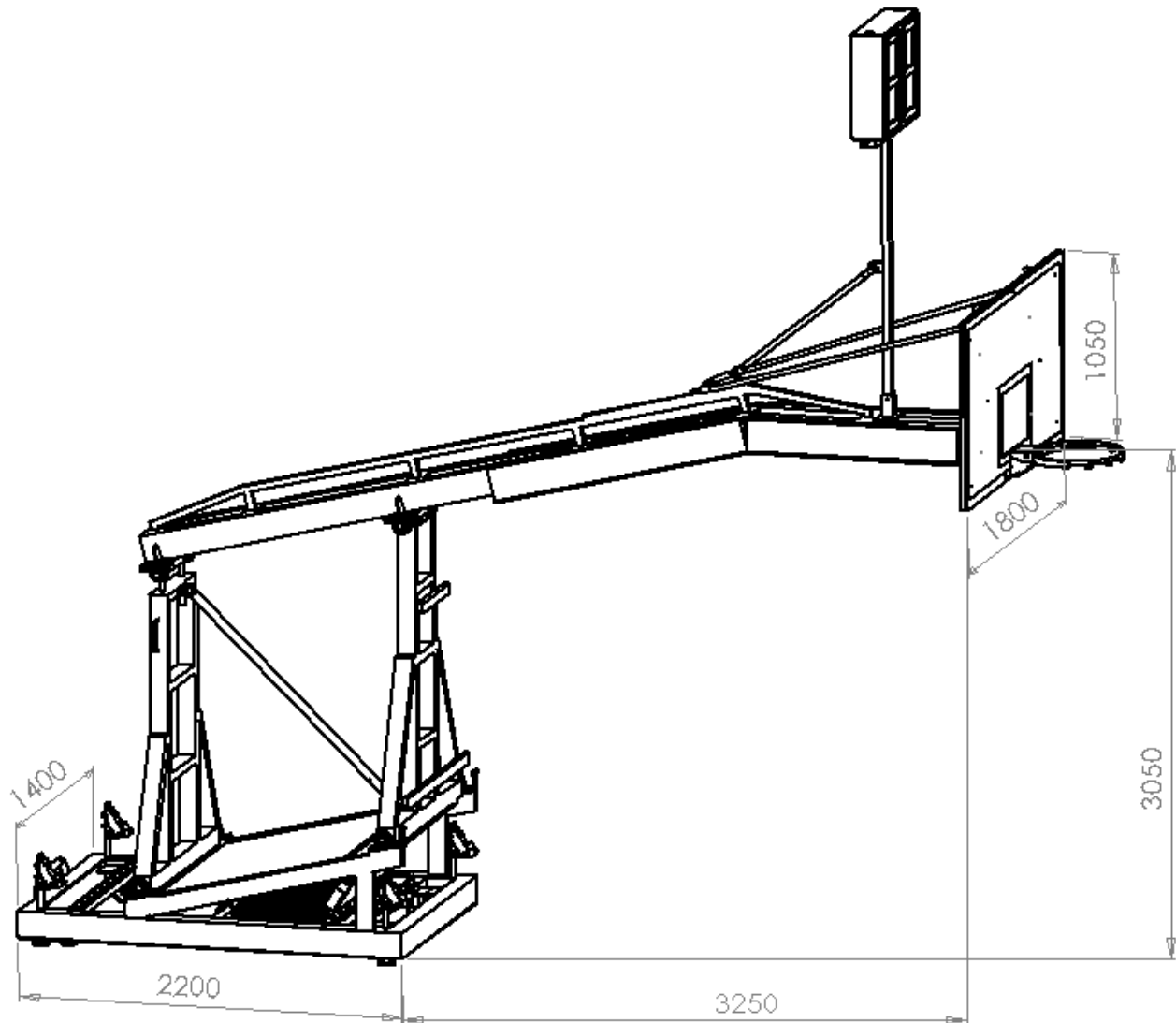

DIMENSIONS

The basketball goal reference BAMUE has an extension of 3.25m established as per F.I.B.A norm.
The dimensions of the goal during the usage are: 5.45x3.95x1.8 m.

SCHEME MEASURES FOLDED BASKETBALL GOAL

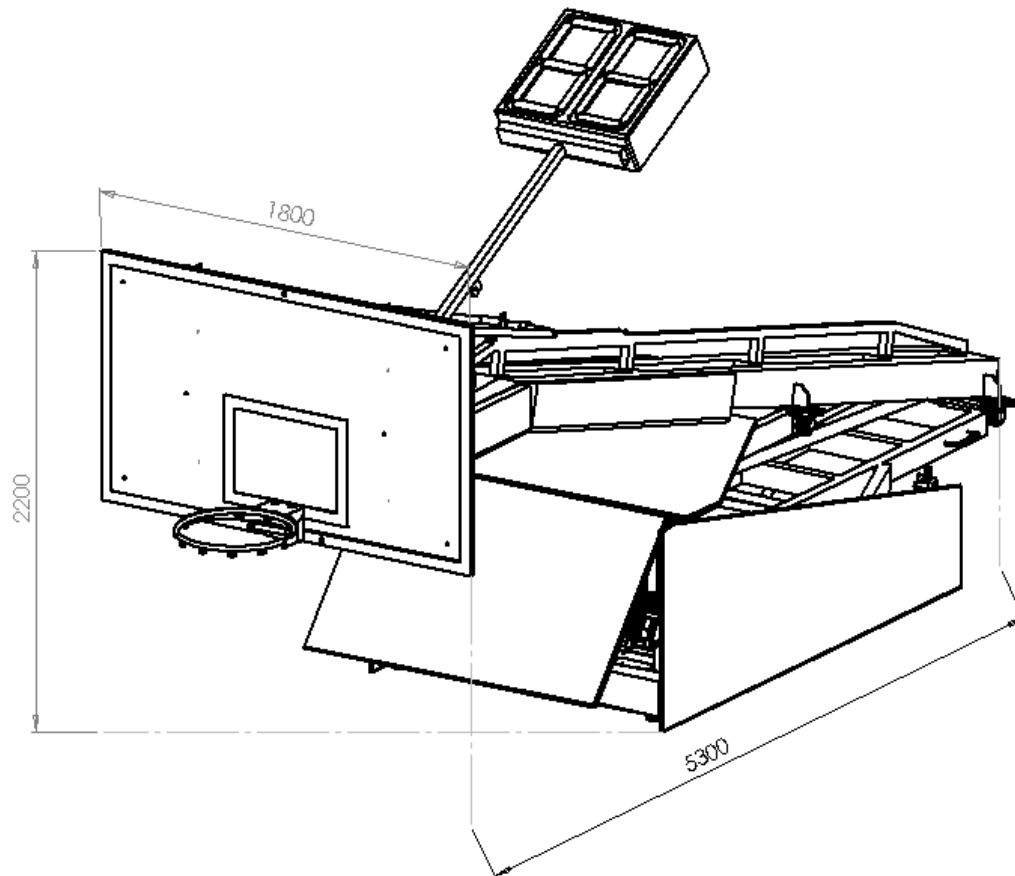

GENERAL DESCRIPTION OF THE BASE

The support base of the basket is very stable, with four rubber discs as a base for its support in the playing position. For its transport it has wheels 200 diameter with bearings, the front wheels are fixed and the rear rotate for its easy portability. The vertical posts attached to the base provide rigidity and stability to the basket when movement saving the game position up to 4 seconds.

Horizontal arm and the backboard support is made of double structural tube welded together giving the necessary rigidity for the game. At the rear, it has 2 levelling threads for perfect levelling.

The backboard incorporates a reinforced metal frame with special fit for the ring, the horizontal arm directly absorbs all the moves of the game. It also incorporates back bars anchored to the arm to keep the verticality and horizontality of the backboard, and it folds to facilitate its storage



REFERENCE	EXTENSION	FOLDED MEASURES	BACKBOARD	ELEVATION	RING	NET
BAMHI021	3.25M	5300x2025mm	20 mm	Hydraulic	FIBA standards	braided